

LASER FLASH SPECTROMETRIC INVESTIGATIONS OF BIRADICALS AND CAGED RADICAL PAIRS

NICHOLAS J. TURRO

Chemistry Department, Columbia University, New York, NY 10027, U.S.A.

(Received in U.S.A. 20 March 1981)

Abstract—The use of laser flash spectroscopic techniques allows the detection, identification and dynamic analysis of biradicals and caged radical pairs in fluid solution at ambient temperatures. The conventional flash spectroscopic device has been advanced with the advent of the Excimer Laser, as an excitation source of the optical multichannel analyzer (OMA) as a detector system and of the transient digitizer (TD) as a data collector and analyzer. The Excimer Laser, in addition to serving as an excitation source, may also induce novel photophysical and/or photochemical events as a result of the unusually high intensities produced by such devices. Examples are given of the use of Excimer Laser-OMA and Excimer Laser-TD systems to study the dynamics of radical pairs that are caged in micelle aggregates and to study novel emissions produced by photoexcitation of benzophenone and substituted benzophenones.

Photochemical excitation of organic molecules has provided a convenient and exceedingly useful method for the production of biradicals under a variety of experimental conditions.¹ For example, the photoinduced generation of biradicals in matrices allows the investigation of many important physical parameters of these inherently reactive species.² Of course, since the basic concept of matrix isolation is the inhibition of chemical reactivity, information on the latter parameter must be obtained generally by photogeneration of biradicals in fluid solution, commonly near ambient temperatures. Under these conditions the biradicals have lifetimes in the range of nanoseconds. Laser flash spectroscopy (LFS)³ provides a modern method for investigating in a direct experimental fashion the chemical reactivity of biradicals in fluid solution at or near ambient temperature.

The Excimer laser coupled with an optical multichannel analyzer and transient digitizer. The excimer laser, which became available commercially in the late 1970s, permits photochemists to study chemical systems after excitation with nanosecond pulses of high intensity and of short wavelength. For example, a 10–15 ns pulse of 10^{17} photons at 249 nm is readily available with KrF as the lasing medium. Because the photon density is much higher than that available from other lasers, the excimer laser provides the photochemist with a means of producing unusually high concentrations of reactive species, such as biradicals. This property produces both analytical advantages in detection of transients and opens the possibility of discovering novel photochemistry that results from reactions of short lived transients with other transients.

Two other recently developed detection and analytical devices, the optical multichannel analyzer (OMA) and the transient digitizer (TD), when coupled with the Excimer Laser as an excitation source provide a powerful combination for the investigation of photochemical mechanisms. A schematic of the Excimer-OMA-TD system used at Columbia is given in Fig. 1. The OMA allows the recording of an entire emission spectrum on the nanosecond time scale in a one shot experiment after the flash or during steady state excitation of a sample. The TD

allows rapid acquisition and handling of the absorption or emission data produced by a flash excitation. Examples will be given of the use of Excimer Laser-OMA and Excimer Laser-TD combinations to identify biradicals and to investigate their dynamics.

Laser induced emission from precursors of diphenylcarbene. The Excimer Laser-OMA method can be employed as a method of detecting and identifying transients and/or products of photoreactions even when the yields of these species is so low as to be difficult or impossible to detect by conventional methods. In particular, the transient/product is readily detected if it possesses a distinct emission spectrum, a high emission yield and a strong absorption at the laser excitation wavelength.

As an example consider the Excimer Laser-OMA

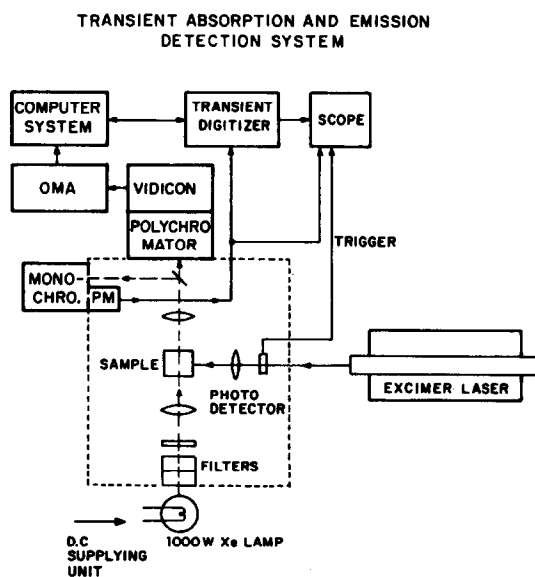

Fig. 1. The Excimer Laser-OMA-TD System. The laser is a Lambda-Physik 101 Excimer Laser. The OMA is a product of Princeton Applied Research, and the TD is a Tektronix model WP2250.

emission spectrum produced by photolysis of diphenyldiazomethane and tetraphenylloxirane, both known to be excellent precursors of diphenylcarbene. In nitrogen purged isooctane solution at room temperature, the emission spectrum of diphenylcarbene (established by comparison with the spectrum of authentic material at 77K) is observed readily (Fig. 2, curve a).⁴ After 10 or more laser pulses, the emission of diphenylcarbene is replaced by an emission identified as that of 9,10-diphenylanthracene (DPA) a molecule that had not previously been observed as a product of diphenylcarbene (Fig. 2, curve b).

Conventional vapor chromatographic analysis of the reaction demonstrated that tetraphenylethylene is the major reaction product. Furthermore, DPA is not produced via photolysis with a conventional steady light source. Thus, the Excimer Laser-OMA method produces novel photochemistry and provides a method of detecting that photochemistry.

The Excimer Laser-OMA spectra of O₂ purged isooctane solutions are strikingly different from those for N₂ purged samples (Fig. 3). Two new product emissions, assigned to benzophenone phosphorescence and to the diphenylketyl radical, are observed. Presumably, the reaction of diphenylcarbene with oxygen produces benzophenone triplets or benzophenone ground states during the initial portion of the 15–20 ns laser pulse. The benzophenone triplets in turn abstracts hydrogen from the isooctane solvent to yield diphenylketyl radicals. The latter transients then absorb a photon from the tail of the laser pulse and emit fluorescence. Thus, the Excimer Laser-OMA method allows the photochemist to follow in a single, one shot experiment the course of a series of process occurring on the nanosecond time scale by inducing the process with an initial excitation and then allowing the detection of the process by inducing emission of products and transients.

Intersystem crossing for a 1,1-biradical

Diphenylcarbene. Intersystem crossing may be rate limiting in the reaction of triplet biradicals.⁵ This will be the case if intramolecular disproportionation or combination reactions, which are generally efficient only for singlet biradicals, are the major reactive channels available to the biradical. In collaboration with Prof. Kenneth Eisenthal we have employed a combination of nanosecond and picosecond time correlated spectroscopy to measure the rates of intersystem crossing for a 1,1-biradical: diphenylcarbene.⁶

Photolysis of diphenyldiazomethane yields singlet diphenylcarbene upon loss of N₂ from the excited singlet state of the diazo compound. In the picosecond work, the rate of buildup of diphenylcarbene triplet was measured directly by monitoring the fluorescence of diphenylcarbene triplet (³DPC). From these experiments a rate constant of $9 \times 10^9 \text{ s}^{-1}$ was deduced for the process DPC singlet → DPC triplet, the latter being the carbene ground state.

Although ³DPC is the ground state of this species, in the absence of rapid reaction, an equilibrium ¹DPC ⇌ ³DPC is set up.⁷ By appropriate selection of a reagent that reacts selectively with ¹DPC (i.e. MeOH) and a reagent that reacts selectively with ³DPC (i.e. isoprene) the rate of constant for the process ³DPC → ¹DPC can be deduced from a combination of chemical data on relative reactivity, and nanosecond laser flash measurements.

We have investigated the system described in Scheme I by using methanol and isoprene (IP) as selective ¹DPC and ³DPC traps, respectively. Alcohols are generally accepted to react with ¹DPC to yield ethers by OH insertion, and 1,3-dienes have been shown to be efficient traps of triplet carbenes.⁷ We have found that the ratio of the two isomeric cyclopropanes formed upon reaction of DPB with isoprene is independent of isoprene con-

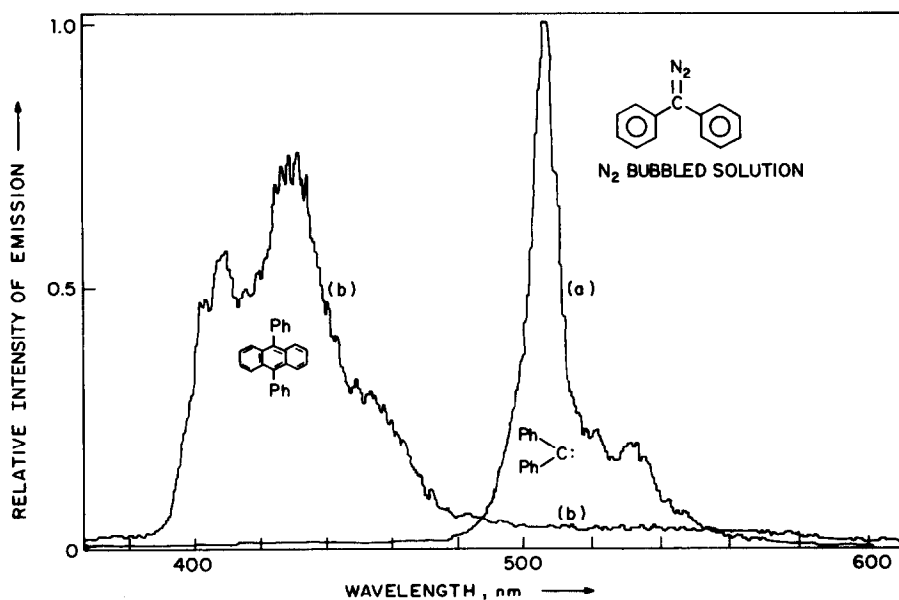

Fig. 2. Emission spectra obtained by OMA analysis for diphenyl carbene ($1.0 \times 10^{-4} \text{ M}$) of N₂-bubbled isooctane solution of carbene precursor: (a) Emission spectrum for first pulse and (b) after 13-pulse irradiation. The species responsible for the various emissions is indicated by the structure drawn beneath the bands. Pulse intensity is 180 mJ/pulse at 249 nm. Similar results were obtained with diphenyl diazomethane or tetraphenyl oxirane as precursor.

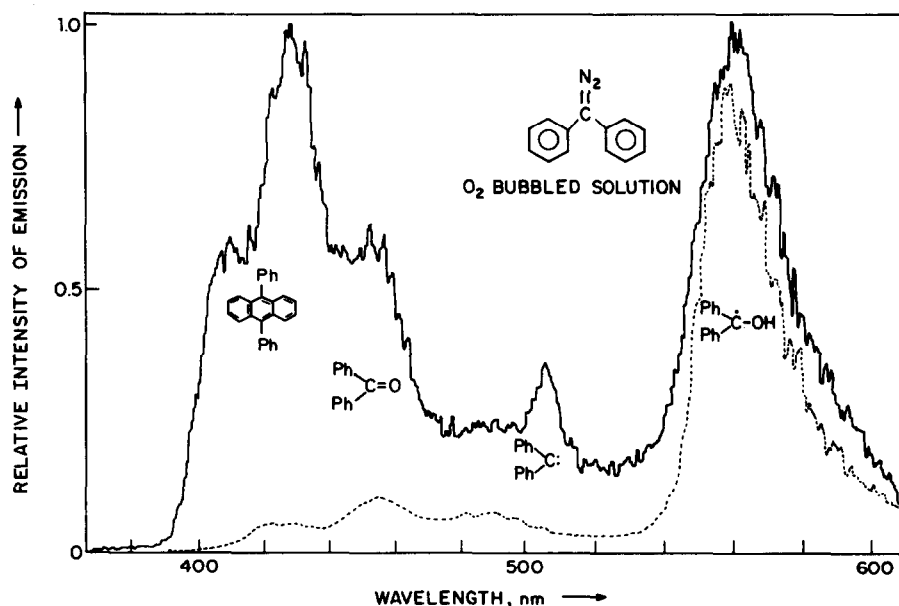
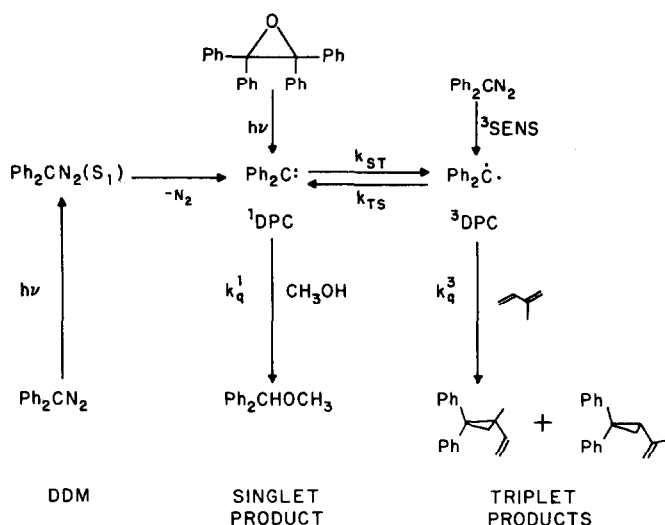

Fig. 3. Emission spectra of transients and product of diphenyl carbene obtained by OMA analysis. The spectra were recorded after N_2 purging the isooctane solution of a carbene precursor (1.0×10^{-4} M) which had previously been irradiated with 30 pulses at room temperature while saturated with O_2 . The dotted spectrum was obtained for benzophenone in N_2 -bubbled isooctane solution. The species responsible for the various emissions are indicated by the structure drawn beneath the bands.

centration in the range 10^{-1} – 10 M. Furthermore, the same ratio of cyclopropanes is produced by direct excitation or triplet sensitization of diphenyldiazomethane in the presence of a high concentration of MeOH and a low concentration of isoprene. These results define isoprene as a selective trap of 3 DPC.

The occurrence of spin state selective reactions allows one to predict the ratio of the quantum yield triplet products ($^3\phi$) to the quantum yield of singlet products ($^1\phi$) will obey eqn (1). A plot of $^3\phi/^1\phi$ vs the concentration of isoprene, [IP], is expected to exhibit two limiting

$$^3\phi/^1\phi = \frac{k_{ST}}{k_{TS} + k_q^3[IP]} \frac{k_q^3[IP]}{k_q^1[CH_3OH]} \quad (1)$$

domains. In the first domain for which $k_{TS} \gg k_q^3[IP]$, and eqn (1) reduces to eqn (2).

$$^3\phi/^1\phi = \frac{k_{ST}}{k_{TS}} \frac{k_q^3[IP]}{k_q^1[CH_3OH]} \quad (2)$$

In this domain, the slope of a plot of eqn (2) yields a value for the quantity $(k_{ST}/k_{TS})(k_q^3/k_q^1[CH_3OH])$. In the second domain, $k_{TS} \ll k_q^3[IP]$ and eqn (1) reduces to eqn (3).

$$^3\phi/^1\phi = \frac{k_{ST}}{k_q^1[CH_3OH]} \quad (3)$$

DPC was generated by the direct photochemical excitation of either diphenyldiazomethane (DDM) or tetraphenylloxirane (TPO)⁸ in the presence of a fixed concentration of methanol (0.05 M) and with varying amounts of isoprene. From the yields of cyclopropanes and diphenylmethyl methyl ether (Scheme I), the ratio ${}^3\phi^1\phi$ was computed as a function of [IP]. From Fig. 4 it can be seen that a plot of the form expected from eqn (1) is obtained. Support for the intermediacy of free DPC is provided by the observation that direct irradiation of either DDM or TPO yields experimentally indistinguishable values of ${}^3\phi^1\phi$. Evidence for a rapid ${}^1\text{DPC} \rightleftharpoons {}^3\text{DPC}$ equilibrium relative to reaction (in the domain) is provided by the observation that triplet sensitization of the decomposition of DDM yields the same values of ${}^3\phi^1\phi$ as direct photolysis of DDM.

From the data in Fig. 4 and use of eqns (2) and (3) for the appropriate domains, we compute $(k_{\text{ST}}/k_{\text{TS}})(k_{\text{q}}^3/k_{\text{q}}^1) = (5.5 \pm 0.8) \times 10^{-2}$, $k_{\text{ST}}/k_1 = 0.26 \pm 0.04$ M, and $k_{\text{q}}^3/k_{\text{TS}} = 0.21 \pm 0.03 \text{ M}^{-1}$. The absolute rate constant k_{q}^3 was determined to be $(3.5 \pm 0.5) \times 10^5 \text{ M}^{-1} \text{ s}^{-1}$ by nanosecond laser flash spectroscopy⁹ by monitoring the triplet-triplet absorption spectrum of diphenylcarbene produced by Excimer Laser excitation of DDM or TPO. Thus, k_{TS} is calculated to be $(1.7 \pm 0.3) \times 10^6 \text{ s}^{-1}$.

Combining the values of k_{ST} with that for k_{ST}/k_1 (measured from Fig. 4) allows evaluation of $k_{\text{q}}^1 = (3.5 \pm 0.5) \times 10^{10} \text{ M}^{-1} \text{ s}^{-1}$. The latter is very close to the value for diffusion-controlled reaction in acetonitrile. From knowledge of k_{ST} and k_{TS} , the equilibrium constant and free energy for the process ${}^1\text{DPC} \rightleftharpoons {}^3\text{DPC}$ are computed to be $\log K = 4.0 \pm 0.7$ and $\Delta G = 5.4 \pm 1$ kcal/mole, respectively, at 25°.

Thus, ${}^1\text{DPC}$ behaves like a zwitterion and reacts near the diffusional rate in its reaction with MeOH. ${}^3\text{DPC}$ is so unreactive toward MeOH, that its major pathway for deactivation in neat MeOH may be ${}^3\text{DPC} \rightarrow {}^1\text{DPC} \rightarrow \text{MeOH addition}$. We estimate that rate constant of reaction of ${}^3\text{DPC}$ with MeOH is $< 10^4 \text{ M}^{-1} \text{ s}^{-1}$. This means

that there is over six orders of magnitude difference in the reactivity of ${}^1\text{DPC}$ and ${}^3\text{DPC}$ toward MeOH.

Radical pairs in micelles. Although the term biradical is non-controversially reserved for a species possessing a single molecular framework, the question arises as to whether or not the properties that the molecular framework imposes are more than structural. Many of the special properties of a biradical have to do with the spacial confinement of two "odd" electrons to a region of space that is of the order of 10 Å or less. Except in the case of extensive conjugation, the fact that the "odd" electrons exist on a common molecular framework *per se*, is not a dominating consideration. For example, the properties of spin correlation and electron exchange are crucial in a discussion of the properties of biradicals,⁵ yet the relationship of these properties to the "inert" molecular framework holding the odd electron centers is rarely emphasized.

A primary geminate radical pair possesses, at its birth, the spin correlation and electron exchange properties of a typical small biradical. These properties fade away in a few nanoseconds when the pair is in a non-viscous medium, as the fragments of the pair separate into space and the fragments achieve random distributions in the environment. If, at some later time, these random fragments achieve the proximity of a radical pair, the latter possesses the properties of a spin relaxed or of a random radical pair.

An organic radical pair that is solubilized by a micelle aggregate possesses certain properties that are analogous to those of a biradical. The hydrophobic micellar interior constrains the radical fragments to a restricted space in a manner similar to the constraints imposed by the molecular framework of a biradical. The experimental consequences of the spacial constraints imposed on the radical pair by the micelle are substantial. For example, it has been shown that the cage effect for benzyl radical recombination to form 1,2-diphenylethane is ~0% for the photolysis of dibenzyl

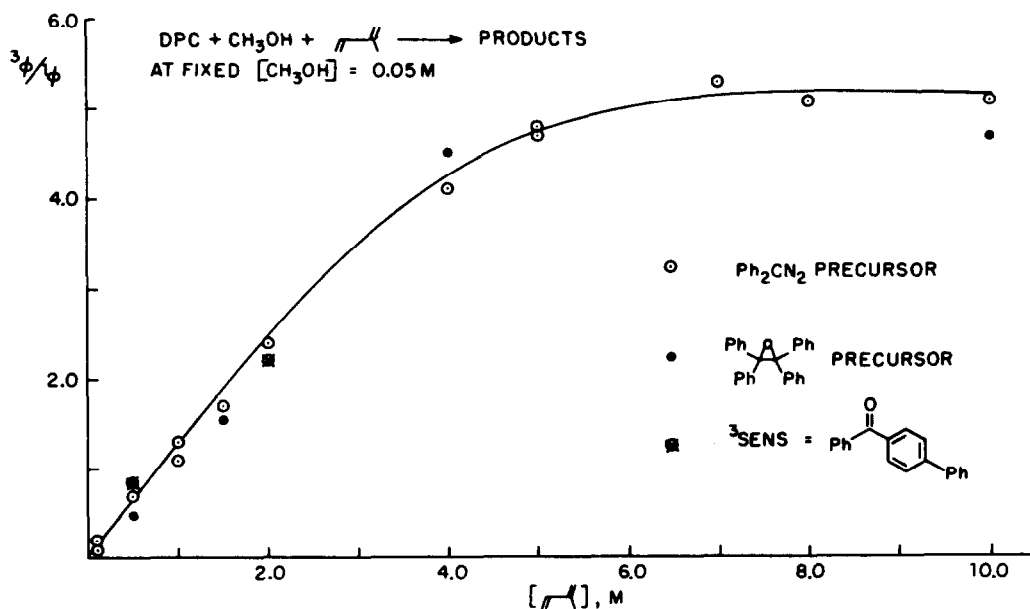

Fig. 4. The ratio of cyclopropanes to ether (${}^3\phi^1\phi$) formed by reaction of DPC in acetonitrile solvent, at fixed (0.05 M) concentration of methanol and variable concentrations of isoprene.

ketone in non-viscous, homogeneous solvents such as benzene and methanol.⁹ In micellar aggregates,¹⁰ however, the cage effect rises to values exceeding 30% (Table 1). Furthermore, the application of weak laboratory magnetic fields (< 500 G) causes substantial reduction of the cage effect (30 → 15%). There is no magnetic field effect on the cage reaction of dibenzyl ketone in homogeneous solution, i.e. it is ~0% in the presence and absence of a magnetic field.

The proposed basis for the magnetic field effect¹¹ is shown in Fig. 5. If nuclear electron hyperfine interactions provide the major mechanism for intersystem crossing of the radical pair, than at zero field all three triplet sublevels (T_+ , T_- and T_0) of a triplet radical pair can undergo intersystem crossing to the singlet radical pair, S, i.e. the three triplet sublevels are degenerate with each other and degenerate with S. Application of an external magnetic field splits T_+ and T_- energetically away from T_0 which remains degenerate with S. When the splitting of T_+ and T_- from T_0 is energetically greater than the hyperfine interaction, intersystem crossing between the T_+ and T_- triplet sublevels is inhibited and only T_0 is capable of efficient intersystem crossing to S. This means that the cage effect will decrease as a magnetic field is applied because one or both of the fragments of T_+ and T_- radical pairs (unable to intersystem cross to S) will diffuse out of the micelle eventually and become scavengable, random free radicals. Since the magnitude¹² of the summation of hyperfine interactions in benzyl radicals pairs is < 100 G, very weak magnetic field will suffice to reduce the cage effect.

It is expected that the external magnetic effect on the radical pairs will only operate effectively as long as the pair is spin correlated, i.e., for times up to 100 ns. After this time random spin relaxation processes will cause a loss of spin correlation. This expectation can be tested experimentally by monitoring the behavior in micellized benzyl radical pairs.

Excimer Laser flash excitation of micellized dibenzyl ketone followed by conventional absorption measurements on the nanosecond time scale,¹³ leads to the production of a transient absorption shown in Fig. 6. The spectrum is quite similar to that assigned to the benzyl radical in homogeneous solution.

Typically, dibenzyl ketone in aqueous solutions of

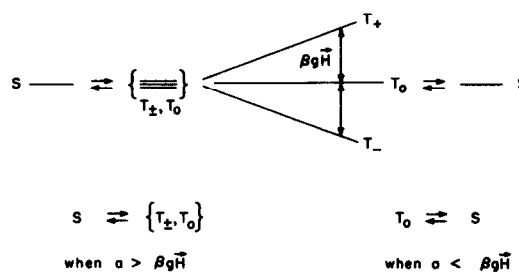

Fig. 5. Schematic representation of the Zeeman interaction $\beta g \bar{H}$ on the energetic separation of T_+ , T_- and T_0 . When Zeeman interaction is small relative to other interactions (such as hyperfine interaction whose strength is given by a , the hyperfine splitting constant), the triplet and singlet states are energetically degenerate and all three triplet sublevels interconvert with the singlet state. When $\beta g \bar{H}$ is large relative to a , $T_0 \rightleftharpoons S$ intersystem crossing occurs. The effect of $\beta g \bar{H}$ is to energetically split T_+ from S and thereby inhibit intersystem crossing from or to these sublevels.

hexadecyltrimethyl ammonium chloride (HDTCl) was excited by a 15 ns pulse of 249 nm light produced by an Excimer Laser. The transient absorption data was collected and analyzed by a transient digitizer. The decay of benzyl radical absorption in methanol and in isooctane clearly follows second order kinetics in the time range of 50–50,000 ns. Thus, as expected, the disappearance of benzyl radicals in homogeneous solution, in the time range of interest, occurs predominately via combination of random free radicals.¹⁴ In the same time domain, the decay of benzyl radicals (monitored by absorbance or optical density) in micellar solution is complex (Figs. 7 and 8), but can be analyzed in terms of a magnetic field independent "fast" first order decay (rate constant, k_f) and a magnetic field independent "slow" first order decay (rate constant, k_s), i.e. in terms of eqn (4), where $I(t)$ is the measured

$$I(t) = I_f \exp(-k_f t) + I_s \exp(-k_s t) \quad (4)$$

optical density at time, t , I_f and I_s are fitting parameters and k_f and k_s are the rate constant for the fast and slow decays, respectively.

Figure 9 summarizes a working mechanism for the

Table 1. Cage effects for formation of 1,2-diphenyl ethanes in micellar solution^a

	CAGE EFFECT	
	0 G	1000 G
	30 %	15 %
	50 %	30 %
	60 %	30 %
	98 %	70 %

(a) Results refer to hexadecyltrimethylammonium chloride solutions, above the critical micelle concentration.

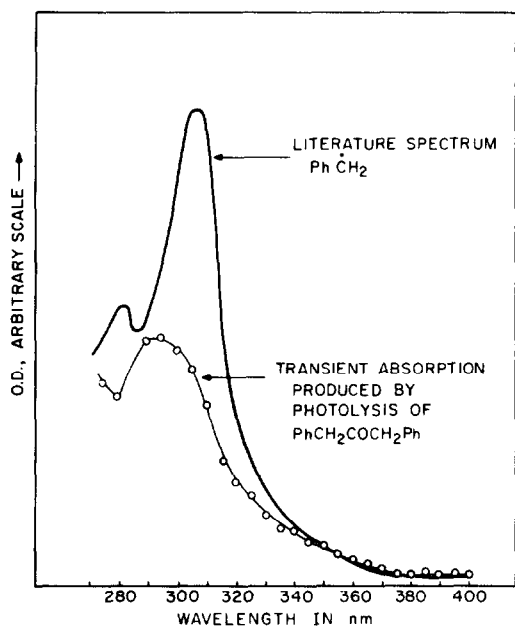

Fig. 6. Transient absorption produced by Excimer Laser pulsed excitation of dibenzyl ketone in micelle solution (lower curve).

interpretation of the data in Table 1. From data in the literature, the time scale for decarbonylation of $C_6H_5CH_2CO$ radicals is of the order of 10^{-8} sec. Therefore, we expect decarbonylation to be nearly complete at the initial time periods investigated (~ 50 ns), and, as a result, the first significant transient species detected in our measurements are expected to be spin correlated triplet benzyl radical pairs. Since the total benzyl radical concentration is being monitored in our experiments, the decay of benzyl radical absorption may be due to

recombination by paths a, b, or c (it is assumed that formation of a singlet radical pair in a micelle is rate determining for a combination event). In the time region analyzed (~ 50 – $50,000$ ns), path c may be ruled out as a significant contributor for combination of benzyl radicals based on the following arguments: (1) the decay by path c would follow second order kinetics, whereas the "fast" and "slow" decays are both first order; (2) although benzyl radicals escaping from micelles have been found to be efficiently scavenged by aqueous Cu(II), the "fast" and "slow" decays are identical in the absence of Cu(II) or in the presence of 4×10^{-3} M Cu(II); (3) the fast and slow decays of 4-tert-butyl benzyl radicals (which are known to combine efficiently before escaping the micelle) are comparable to those for benzyl radicals; (4) the time scale for the slow process is of the order (10^{-4} sec) expected for electronic spin relaxation of benzyl radicals.¹⁵

From Fig. 7 it can be seen that the application of a weak (400 G) magnetic field slows down the rate of fast decaying of benzyl radical pairs. From Fig. 8 it is noted that the application of a weak magnetic field does not significantly change the rate of slow decaying benzyl radicals.

Only recently have time resolved magnetic field effects on the dynamics of radical pairs been measured.¹⁶ Our results confirm many of the conclusions concerning the behavior of radical pairs in micelles that were proposed on the basis of steady measurements.¹⁷ It is noteworthy that the time scales for geminate reactions of radical pairs in micelles are now confirmed, by direct spectroscopic measurement, to be several orders of magnitude greater than the time scale for analogous processes in homogeneous solution.

In summary, the laser flash excitation of DBK in HDTCI solution produces geminate triplet radical pairs in micelle aggregates. These geminate pairs decay by two major pathways in the time domain 50–50,000 ns: ISC of spin correlated triplet radical pairs followed by recom-

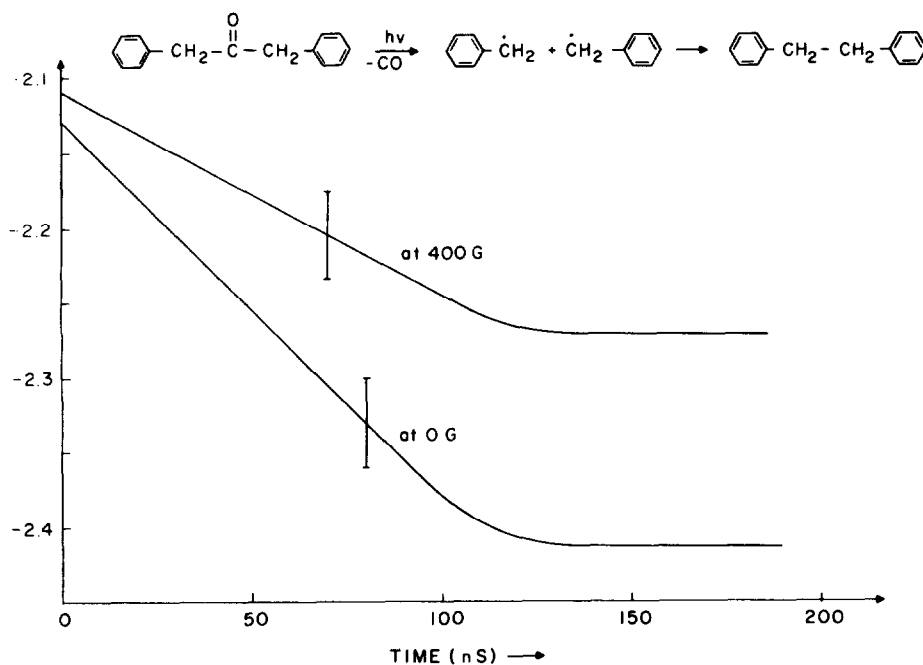

Fig. 7. Decay of the absorption of micellized benzyl radicals in the time domain 50–200 ns in the absence (lower curve) and in the presence (upper curve) of an applied magnetic field.

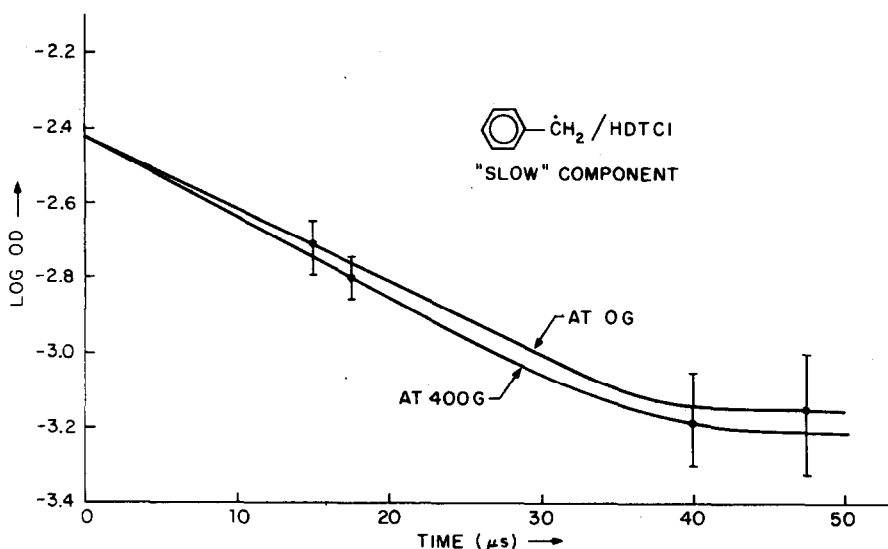

Fig. 8. Decay of the absorptions of micellized benzyl radical in the time domain ~ 500 – $50,000$ ns in the absence and in the presence of a laboratory magnetic field.

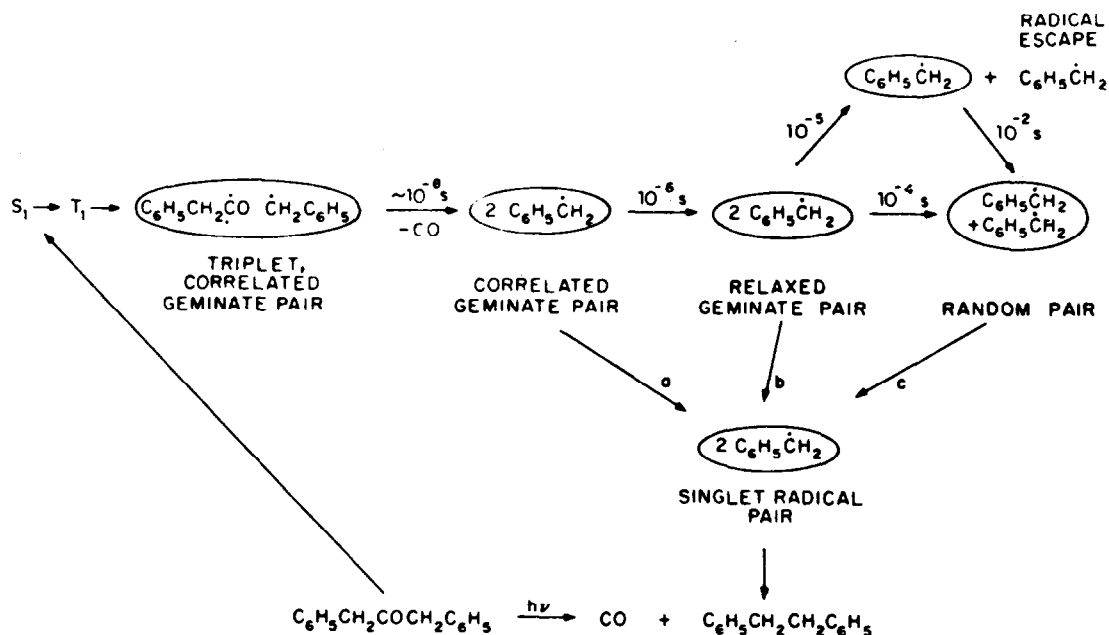

Fig. 9. Proposed mechanism to explain the fast and slow decaying micellized benzyl radical pairs.

bination of singlet radical pairs to form diphenylethane (k_r) and recombination of relaxed geminate radical pairs to form diphenylethane (k_r). The rate of spin correlated ISC is substantially decreased by application of a magnetic field of 400 G and is substantially increased by ^{13}C in the CH_2 groups of the benzyl radicals. The relaxed geminate radical pairs are not sensitive to either magnetic effect. The escape of benzyl radicals from micelles occurs on a longer time scale than that explored in this investigation.

Unprecedented laser excitation induced emission of benzophenones. The emission spectrum of benzophenone in "inert" fluid solutions at ambient temperatures is well established to consist mainly of a structured phosphorescence and a very weak (thermally

activated) fluorescence.¹⁸ To our knowledge there are no literature reports of excimer emission from benzophenone triplets, although triplet quenching may proceed via such complexes.¹⁹ Figure 10 shows the OMA emission of benzophenone in freon at room temperature as a function of excimer laser intensity. Each spectrum is normalized at 424 nm. At the smallest laser intensities (25 mJ) the spectrum is nearly identical to that of the OMA emission of benzophenone excited by conventional steady state photoexcitation. At the largest laser intensities the occurrence of an unprecedented emission in the region 500–540 nm is clearly observed. Since the spectra at any intensity do not change after 100 laser shots and since the absorption spectra of the samples are virtually unchanged after many laser shots, the new

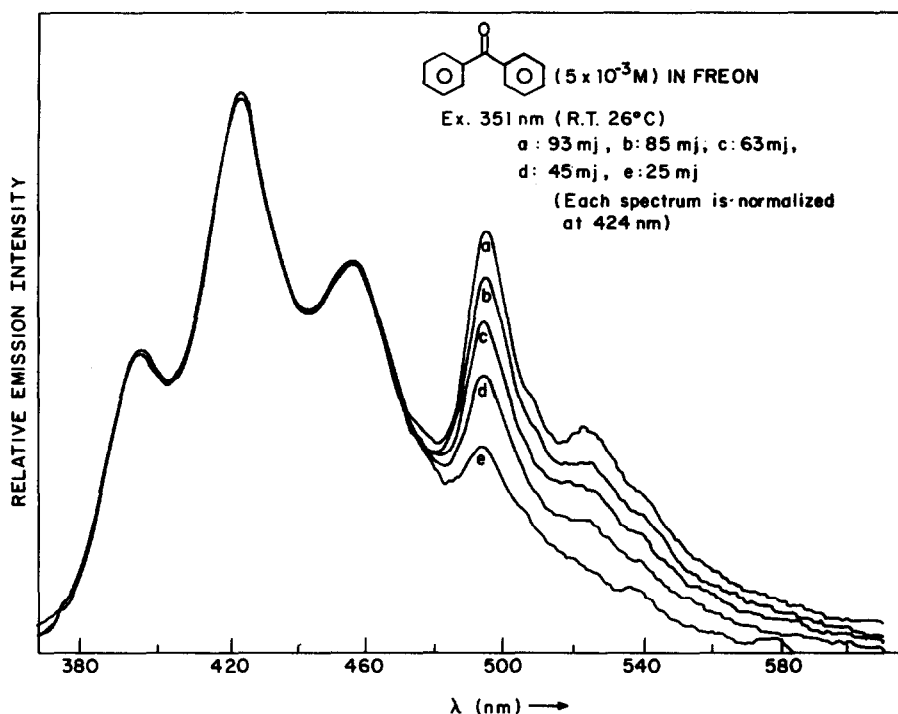

Fig. 10. OMA emission of benzophenone in freon as a function of exciting laser intensity. Curve e is qualitatively identical to the emission observed with normal steady state lamp excitation.

Table 2. Novel laser induced emission of benzophenone and substitute benzophenones in freon solvent at room temperature

<u>Benzophenone</u>			
<chem>X-C6H4-C(=O)-C6H4-Y</chem>		$\lambda_{\text{normal max}}$ (nm)	$\lambda_{\text{laser max}}$ (nm)
x	y		
H	C_6H_4	absent	absent
H	OCH_3	448	absent
H	CH_3	450	532
H	H	451	525
H	Cl	453	539
H	CO_2CH_3	465	556
$\text{N}(\text{CH}_3)_2$	$\text{C}(\text{CH}_3)_2$	absent-weak	absent
OCH_3	OCH_3	444	absent
Cl	Cl	454	548
CO_2CH_3	CO_2CH_3	471	547
CF_3	CF_3	461	532

emission is unlikely to be due to irreversible photoreaction.

The novel emission is not unique to benzophenone, but is observed for a wide variety of mono- and di-substituted benzophenones (Table 2). Qualitatively, electron releasing substituted benzophenones do not display the novel emission whereas electron withdrawing substituted benzophenones do. Although further experiments are required to nail down the mechanistic details for the origin of the novel laser induced emission of benzophenones, one intriguing speculation is the possibility that two excited states of benzophenone are involved as

a precursor to the emission, e.g. two benzophenone triplets can interact to yield the emitting species. Normally, one expects excimer (or exciplex) emission to result from the interaction of a single excited state and a ground state. However, it might be that the rate of formation of excimers is faster or more efficient when two excited states interact. A second possibility is that the emission is due to an adiabatic reaction of two excited states leading to a product that is capable of emission. A viable candidate for such a reaction would be excited state biradical formation which results from

the addition of an excited benzophenone to a second, excited molecule of benzophenone.

Acknowledgements—The author thanks the Air Force Office of Scientific Research and the National Science Foundation for their generous grants. Experimental skills of Dr. M. Aikawa, Dr. J. Butcher, Dr. M.-F. Chow, Dr. B. Kraeutler, Dr. Y. Tanimoto, Mr. C.-J. Chung and Mr. G. Weed are gratefully acknowledged.

REFERENCES

- ¹N. J. Turro, *Modern Molecular Photochemistry*, Chaps. 10–13. Benjamin/Cummings, Menlo Park (1978).
- ²O. L. Chapman, *Pure Appl. Chem.* **40**, 511 (1974) and refs therein.
- ³J. C. Scaiano, *J. Am. Chem. Soc.* **102**, 5399 (1980) and refs therein.
- ⁴N. J. Turro, M. Aikawa, J. A. Butcher and G. W. Griffin, *Ibid.* **102**, 5127 (1980).
- ⁵L. Salem and C. Rowland, *Angew. Chem. Int. Ed. Engl.* **11**, 92 (1972).
- ⁶K. B. Eisenthal, N. J. Turro, M. Aikawa, J. A. Butcher, C. DuPuy, G. Gefferon, W. Hetherington, G. M. Koerenowski and M. J. McAuliffe, *J. Am. Chem. Soc.* **102**, 6563 (1980).
- ⁷D. Bethell, G. Stevens and P. Tickl, *J. Chem. Soc. D*, 792 (1970). F. L. Closs, *Top. Stereochem.* **3**, 193 (1968). W. Kirmse, *Carbene Chemistry* (2nd Edn.) Academic Press, New York (1971).
- ⁸H. Kristinsson and G. W. Griffin, *Angew. Chem. Int. Ed. Engl.* **4**, 868 (1965). *J. Am. Chem. Soc.* **88**, 1579 (1966); A. M. Trozzolo, W. A. Yager, G. W. Griffin, H. Kristinsson and I. Sarkov, *Ibid.* **89**, 3357 (1967).
- ⁹P. A. Engel, *Ibid.* **92**, 6074 (1970); W. K. Robbins and R. H. Eastman, *Ibid.* **92**, 6076, 6077 (1970).
- ¹⁰N. J. Turro, *Pure Appl. Chem.* **53**, 259 (1981); N. J. Turro, M. Gratzel and A. M. Braun, *Angew. Chem. Int. Ed. Engl.* **19**, 675 (1980).
- ¹¹N. J. Turro and B. Kraeutler, *Accounts Chem. Res.* **13**, 369 (1980).
- ¹²H. Paul and H. Fischer, *Helv. Chem. Acta* **56**, 1575 (1973).
- ¹³N. J. Turro, M.-F. Chow, C.-J. Chung, Y. Yanimoto and G. C. Weed, *J. Am. Chem. Soc.*, to be published.
- ¹⁴M. Lehni, H. Schuh and H. Fischer, *Int. J. Chem. Kin.* **11**, 705 (1979).
- ¹⁵C. Walling and A. R. Lepley, *J. Am. Chem. Soc.* **94**, 2007 (1972).
- ¹⁶H. J. Werner, H. Staerk and A. Weller, *J. Chem. Phys.* **68**, 2419 (1978); K. Schulten, H. Staerk, A. Weller, H.-J. Werner and B. Nickel, *Z. Phys. Chem.* **42**, 441 (1979); Y. Sakaguchi, S. Nagakura and H. Hayashi, *Chem. Phys. Letters* **72**, 420 (1980).
- ¹⁷G. Closs and R. J. Miller, *J. Am. Chem. Soc.* **101**, 1639 (1979).
- ¹⁸C. A. Parker and T. A. Joyce, *Trans. Farad. Soc.* **65**, 2823 (1969).
- ¹⁹M. Wolf, R. E. Brown and L. A. Singer, *J. Am. Chem. Soc.* **99**, 526 (1977).